

## Product Line Overview

The Powerex FirstCall™ medical gas alarm systems monitor the status of medical gases in Category 1 healthcare facilities. The alarm systems are ETL listed to UL 1069 and comply with the latest edition of NFPA 99. All alarm systems provide audible and visible indications of NFPA 99 medical gas alarm conditions.

The FirstCall™ Master Alarm system monitors up to 55 signals indicating the operation and condition of the source of supply, the reserve source (if any), and the pressure in the main lines of each medical gas and vacuum piping system in a Category 1 healthcare facility.

The FirstCall™ Area Alarm system monitors the pressure of up to 8 medical gases supplying anesthetizing locations and other Category 1 spaces.

The FirstCall™ Combination Alarm system monitors up to 55 source signals (Master) and up to 6 medical gases (Area) in a single panel.

## Features and Benefits

- Designed and manufactured in the USA
- 5 year warranty on parts, 2 year warranty on labor
- 10" high-resolution touchscreen HMI with 7" VE option available
- Area alarm up to 8 gases
- 4-20mA signal transducers, DISS demand-check fittings, and gas risers included with Area Alarm
- Transducers are able to be remotely installed up to 5,000 ft away
- Master alarm 23, 39, and 55 input signals

- Combination alarm up to 6 gases, 23, 39, or 55 input signals
- Ethernet connectivity using BACnet over IP protocol to building management system - standard
- Alarm signal status can also be viewed on a standard computer connected to the facility's local network via Ethernet
- Customizable emergency instructions in the event of an alarm
- Easy to use interface for setup and changing settings
- Pre-programmed NFPA 99 gas labels and colors
- Event history log accessible at the screen
- Alarm test feature – able to use quickly without logging in
- Area alarm automatically sets NFPA 99 +/-20% limits based on current pressure
- Master alarm pre-programmed NFPA 99 source alarm signals – also customizable
- Master alarm signals organized under main source badge – click through for individual alarm information
- Push-in terminal blocks to easily connect transducer and source equipment alarm signals
- Factory set for normally closed signals, able to change to normally open
- Transducers are gas-specific, and cross-connecting a transducer with an assigned gas input will generate an alarm per 2018 NFPA 99
- Hinged frame for easy assembly and maintenance
- Option for digital outputs – contact factory

## PLC + HMI

Combination PLC+HMI monitors inputs from medical gas transducers and alarm points. Input status displayed on high quality LED HMI touchscreens with compact built in PLC. Preprogrammed standard settings included with all medical gas inputs. Alarm set points, alarm messages and descriptions of sources are fully customizable. Alarm and error history is recorded in Alarm Summary.

The unit is capable of communicating with building monitoring system using Ethernet connection using

BACnet over IP protocol.

Screen sizes include 7" and 10". Both are LED HMI touchscreens.

## Alarm History

The Alarm History screen shows a record of all alarm events up to 32, including the specific alarm condition and the date and time of the alarm event.

## BACNet

- Each alarm panel has an Ethernet port to connect with the facility's building management system via BACnet over IP protocol
- Alarms employ the TCP/IP family of protocols for communication and each device has a unique IP address. The IP address and device ID are customizable
- Each alarm panel conforms to the BACnet protocol and includes a Protocol Implementation Conformance Statement (PICS)

## Power

- Input power to the alarm panel is 110 to 240 VAC +/-10% 50/60 Hz. The toggle control circuit breaker is rated for 2 amps
- The internal power supply converts the input voltage to low voltage 24 VDC
- All user accessible electronics and wiring utilize low voltage

## Maintenance Mode

- When Maintenance mode is toggled, the alarm horn will not activate during a normal alarm event, allowing a technician to perform maintenance without setting off the loud alarm
- The lower right bar on the home screen that is typically green and displays "NORMAL" will now be yellow and display "MAINTENANCE"
- Maintenance mode will automatically toggle back to normal after 15 minutes. A timer is displayed below the button

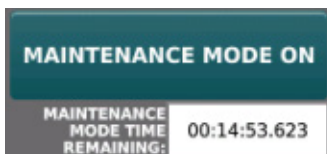

## Area Alarm Gas Badges

- Gas badges are color coded according to NFPA 99
- Indicator bar shows "NORMAL," "LOW," or "HIGH"
- Location bar shows zone served

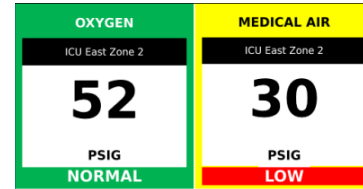

## Master Alarm Gas Badges

- Gas badges are color coded according to NFPA 99
- Indicator shows "NORMAL" or "INPUT" if in alarm
- Press the gas badge to see individual alarm signals and specific alarm conditions

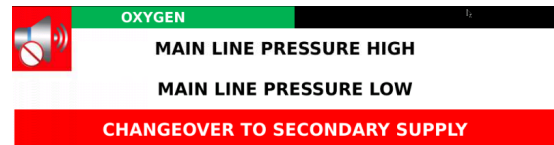
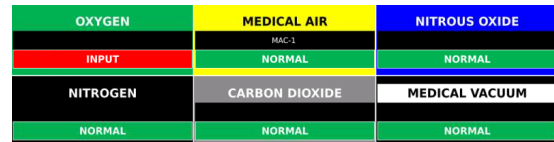

## Combination Alarm Gas Badges

- Gas badges for area signals are the same as the Area Alarm
- Gas badges for the master signals include an indicator on the left side. Green is for "NORMAL" and red is for "INPUT," or alarm. Press the gas badge to see individual alarm signals and specific alarm conditions

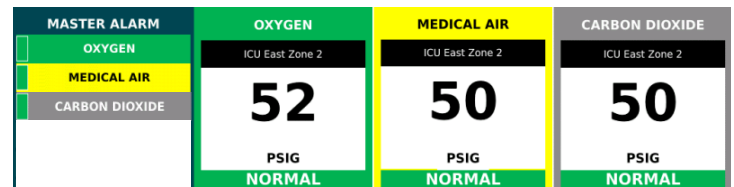

## Configuration of Models

### Area Alarm

AAP7-X thru AAP7-XXXXXXXX (7" panel)

AAP10-X thru AAP10-XXXXXXXX (10" panel)

- X = gas up to 8
- O = Oxygen
- A = Medical Air
- V = Medical Vacuum
- 2 = N<sub>2</sub>O
- N = N<sub>2</sub>
- C = CO<sub>2</sub>
- W = WAGD
- I = Instrument Air

Example: AAP10-OA2VNCWI Area Alarm 10" screen  
Oxygen, Air, Nitrous Oxide, Medical Vacuum, Nitrogen,  
Carbon Dioxide, WAGD, Instrument Air

### Master Alarm

MAP7-YY (7" panel)

MAP10-YY (10" panel)

YY = digital inputs (23, 39, or 55)

Example: MAP10-55 Master Alarm 10" screen 55  
input signals

### Combination Alarm

CAP7-X-YY thru CAP7-XXXXXX-YY (7" panel)

CAP10-X-YY thru CAP10-XXXXXX-YY (10" panel)

- X = gas up to 6
- O = Oxygen
- A = Medical Air
- V = Medical Vacuum
- 2 = N<sub>2</sub>O
- N = N<sub>2</sub>
- C = CO<sub>2</sub>
- W = WAGD
- I = Instrument Air

YY = digital inputs (23, 39, or 55)

Example: CAP10-OAC2NV-55 Combo Alarm 10"  
screen Oxygen, Medical Air, Carbon Dioxide, Nitrous  
Oxide, Nitrogen, Medical Vacuum, 55 input signals

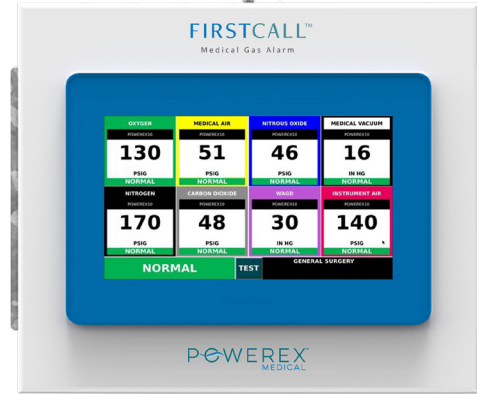

Area Alarm Panel

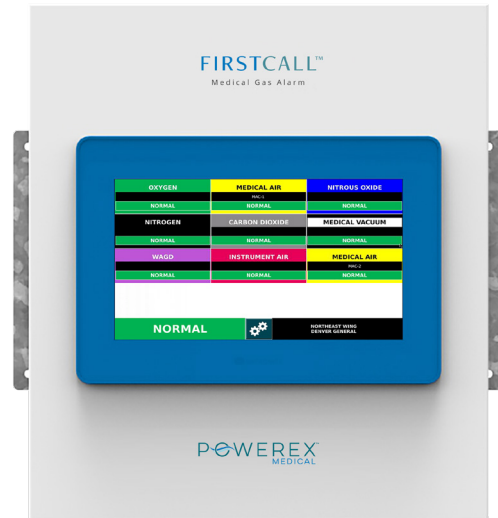

Master Alarm Panel

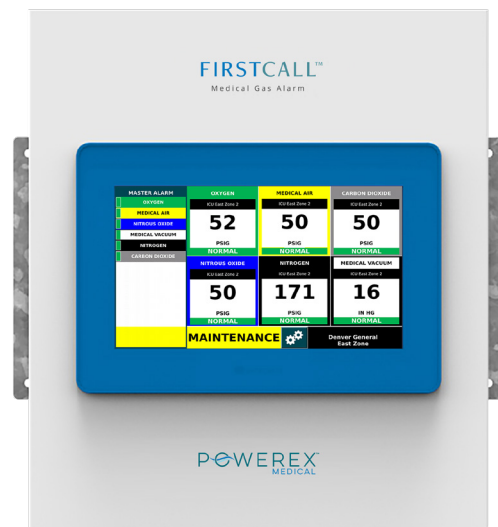

Combination Alarm Panel

## Dimensions

### Standard Configuration

Used for:

- All area alarm panels
- 23 and 39 signal master alarm panels
- Up to 4 gas, 23 signal combo alarm panels

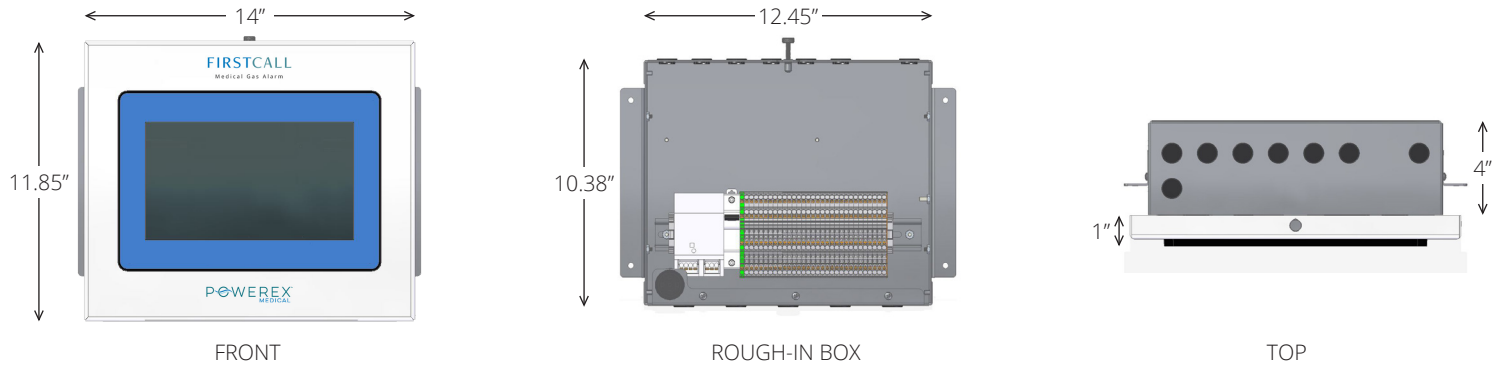

### Expanded Configuration

Used for:

- 55 signal master alarm panels
- 5 through 8 gas, 39 and 55 signal combo alarm panels

