

Defender BELMED INC.

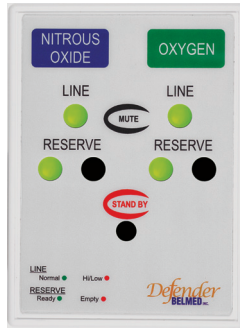

Automatic Changeover Manifold Installation/Instruction Manual

Index

Cylinder Changing Procedure.....	17
Description of Parts.....	5-9
Defender Cable.....	6
Hoses.....	5
Manifold.....	6-9
Remote Alarm Controller Display.....	8
Check Valves.....	7
Control Buttons.....	9
Manifold Display.....	7
The Manifold Enclosure.....	7
Pipeline Connectors.....	6
Regulator Hangers.....	5
Regulators.....	5
Tank Restraints.....	6
Transformer.....	6
Dry Contacts.....	13
Introduction.....	3
Installation Instructions.....	10-12
Line Drawings.....	18-19
Manifold System Description.....	4
Operation.....	16
Purchase Record.....	20
Testing.....	14-15
LED Display Test.....	15
Testing for Automatic Changeover.....	14
Testing for Nitrous Oxide Emergency Cut Off.....	14-15
Testing for Remote Alarm Controller	15
Regulator Adjustment.....	13
User Responsibility.....	2
Warranty.....	21

User Responsibility

The information contained in this Installation and Instruction Manual pertains only to the Belmed Defender Automatic Changeover Manifold. This product will perform in conformity with the descriptions contained in this manual when assembled, operated, maintained and serviced in accordance with the installation instructions provided.

The Belmed Defender Automatic Changeover Manifold incorporates the latest microprocessor technology for change over and alarm control. The manifold has been designed to be easy to use while providing a high level of reliability. This manual will enable the customer to install, use and maintain the manifold properly.

The manifold must be checked periodically. Parts that are broken, missing, worn, distorted or contaminated must be replaced immediately. Should such repair or replacement become necessary, please contact Belmed, Inc. or an authorized Belmed, Inc. Dealer.

Equipment under warranty should not be repaired or altered without prior written approval from Belmed, Inc. Failure to comply with this policy will void all warranty on the manifold.

Statements in this manual preceded by the words WARNING, CAUTION, and NOTE are of special significance. Please read these sections carefully.

Manufactured by Amico Corporation. Distributed by Belmed, Inc.



WARNING: Denotes steps which can prevent injury.



CAUTION: Denotes steps which can prevent damage to equipment.



NOTE: Denotes steps that point our helpful information.

Introduction

The Belmed Defender Automatic Changeover Manifold is designed to provide a reliable, uninterrupted supply of gas to a dental facility. The manifold has the ability to control up to four high pressure cylinders, two dedicated to Oxygen and two dedicated to Nitrous Oxide.

The active cylinder is designated as the primary or "In Use" source of gas, while the other cylinder will serve as a secondary or "Reserve" source. A LED display on the front of the manifold indicates the status of the gas supply. Each gas will have two multi-color LED's that will show the status of each cylinder.

The following colors indicate the status of each cylinder:

Green - In Use

Yellow - Stand-By/ Ready

Red - Empty

When the primary cylinder has been depleted, the manifold will automatically switch to the secondary cylinder without interrupting the supply of gas to the facility. The red LED will illuminate and an alarm will sound when a cylinder has depleted and requires replacement.

The Belmed Defender Automatic Changeover Manifold is designed in accordance with the National Fire Protection Association (NFPA 99).

FEATURES:

Input power to the manifold is 13.5 VDC, 1.7A

Incorporates six multicolored LEDs (three per gas) with two large LED digital pressure displays

High pressure cylinder regulators

Manifold complies with NFPA 99

Line sensors can be mounted with the Zone Valve Box for remote installations

The line sensor module is the smallest, computer-calibrated, temperature-compensated sensor in the industry

Highly accurate, solid state pressure Piezo-resistive transducer

Integrated dry contacts for additional remote monitoring (for multiple locations and building management systems)

Description of Parts

Remote Alarm Controller (RAC)

The Remote Alarm Controller (RAC) is intended to relay information from the manifold room to an area of the office that is consistently monitored. The RAC relays vital manifold information, including high/low line pressures and reserve cylinder status. The RAC will also allow the facility to place the unit in temporary stand-by mode, as well as, mute any alarms. The RAC contains a speaker that provides an auditory signal when the system is in alarm condition.

Remote Alarm Controller Display

The LEDs on the front of the RAC indicate the status of each line and the Reserve.

Line LED	
Status	LED
Normal Line Pressure	Solid Green
Low Line Pressure	Solid Red
High Line Pressure	Flashing Red
Sensor Not Detected	Flashing Yellow

Reserve LED	
Status	LED
Normal	Solid Green
Alarm	Solid Red

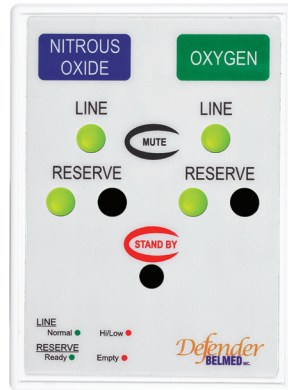

Figure 3

Description of Parts

Manifold

The Manifold Enclosure

The enclosure on this manifold is NEMA-1 (general purpose applications only).

⚠ CAUTION: This cabinet must not be mounted outdoors.

The manifold has a door that opens to allow full access to internal components. The pre-assembled circuit board is located on the inside of the door allowing for easier access. The design will reduce installation time and eliminate the risk of improper installation since all the components of the manifold are connected and tested in the factory.

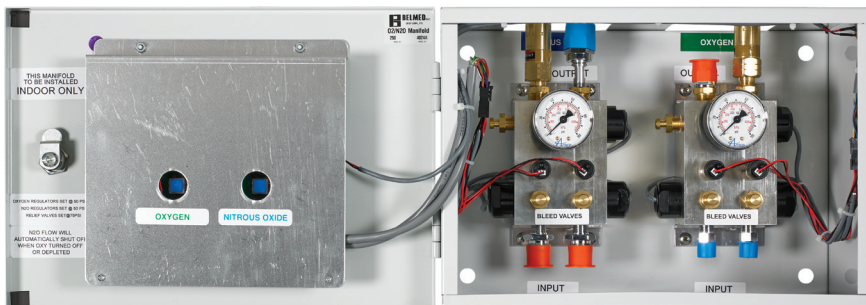

Figure 1

Check Valves

The manifold is equipped with internal check valves to avoid gas migration from “In Use” cylinder to the “Reserve” cylinder and vice versa. A check valve is also located immediately after the solenoids to prevent back flow of line gas.

Manifold Display

The LEDs on the front of the manifold indicate the status of each line and each cylinder.

Line LED	
Status	LED
Normal Line Pressure	Solid Green
Low Line Pressure	Solid Red
High Line Pressure	Flashing Red
Sensor Not Detected	Flashing Yellow

Cylinder LED	
Status	LED
In Use	Solid Green
Reserve	Solid Yellow
Empty	Solid Red
Sensor Not Detected	Flashing Yellow



Figure 2

Only one green LED per gas should be illuminated and each reserve cylinder should have a yellow LED illuminated (if a cylinder has dropped below 40 PSI and is connected to the manifold, or a cylinder has been disconnected from the manifold, a red LED will represent that cylinder).

Manifold System Description

The Belmed Defender Automatic Changeover manifold systems conforms with code requirements specified in NFPA 99 and includes the following code required features:

1. Pressure regulator set at 50 PSI installed on each cylinder.
2. Flexible hose of 1000 PSI burst strength.
3. Connections between regulator and piping system are approved Diameter Index Safety System (DISS).
4. Check valve located down stream of each regulator.
5. Pressure relief valve for each gas pipeline set at 75 PSI, located downstream of each check valve.
6. Restraint to adequately secure cylinders from tipping.
7. Audible and visual alarm for each gas when pressure falls below 40 PSI or increase above 60 PSI.

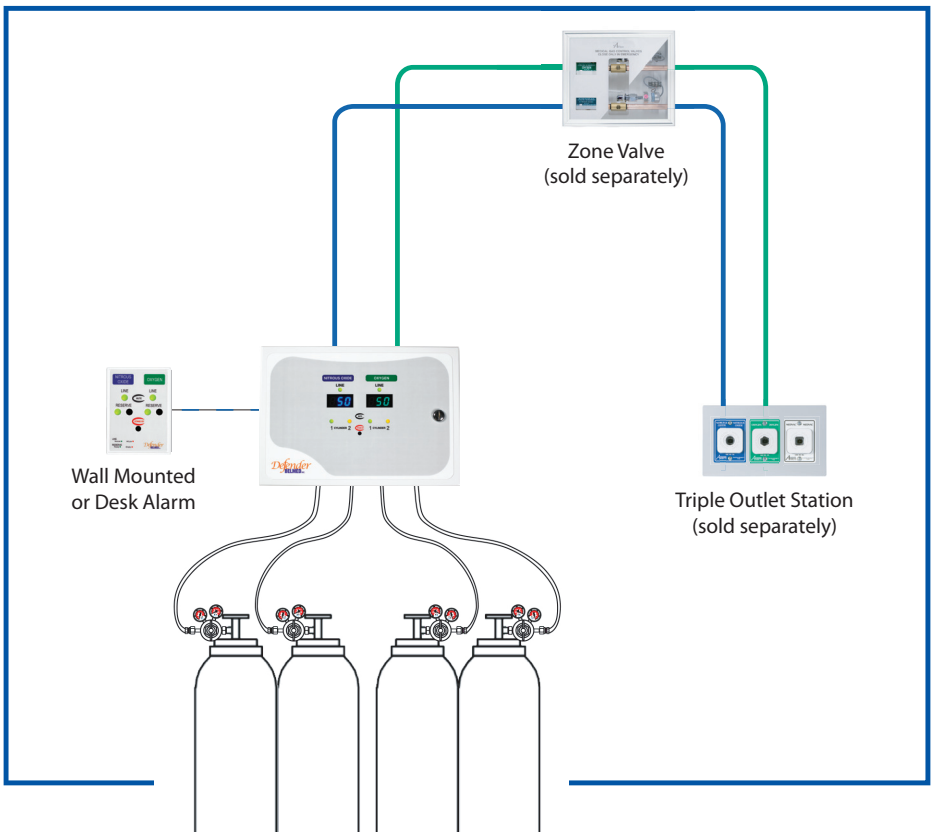

Description of Parts

Defender Cable

A 100ft Plenum CAT5 cable. Connections from manifold to the Remote Alarm Controller must be made using a CAT5 or CAT6 cable. External power for the RAC is NOT required when connected with CAT5 or CAT6 cable.



Tank Restraints

Holds two G/H size cylinders each.



Pipeline Connectors

Pipeline connectors have been supplied to be brazed into the main facility line (follow all local and national codes applicable to your area).



Transformer

Plug in transformer.
Input: 120VAC
Output: 3.5VDC, 1.7A



Installation Instructions



CAUTION: Complete initial pressure test to the medical gas distribution piping before connecting the manifold to the piping.

1. Remove contents from box and confirm that all required equipment has been supplied. Do not discard packing material until the system is in full operation. Keep all manuals and warranty cards.
2. Remove manifold from box and inspect for damage.
3. Pipeline connectors have been supplied to be brazed into the main facility lines. (See page 18)



NOTE: Follow all the local and national codes applicable to your area.

4. Open cabinet door.
5. Make sure that there are not any wires that are disconnected from their terminals.
6. Using the manifold, mark mounting screw locations on the wall and install wall anchors if required. (See page 18)



NOTE: Use appropriate wall anchors for secure installation.



NOTE: It is important to centrally locate the manifold amongst all four cylinders to ensure that all the hoses can reach the appropriate connections. Position the manifold at a height that prevents any interference with the cylinders.

7. Using both Oxygen and Nitrous Oxide pipes, connect the manifold line ports (at the top of the manifold) to the facility's main gas lines.



NOTE: Use two wrenches.

8. Install the tank restraint brackets on the wall as per local codes. Place cylinders in tank restraints and secure. Make certain all valves have been closed.



NOTE: Before connecting regulator to cylinder, momentarily open and close cylinder valve to blow out dirt and debris.

Dry Contacts

In the event that an audible alarm is required in multiple locations of a facility, the manifold is equipped with dry contacts to allow for a remote buzzer to be installed. One or both sets of contacts may be wired to an external alarm, remote buzzer and/or building management system to indicate when an alarm condition occurs.

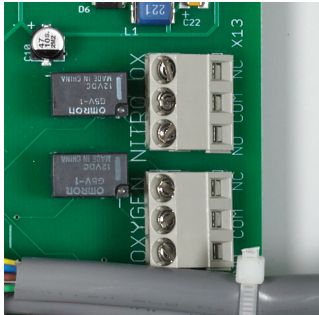

Figure 5

Regulator Adjustment

Regulators come preset from factory at 50 PSI. If regulator needs adjusted, complete the following steps:

1. Look at the digital pressure reading on the manifold display.
 2. Confirm this pressure with the analog gauge.
 3. Regulator adjustment procedure:
 - a) Identify the regulator of the cylinder requiring the pressure change.
 - b) Remove cap nut located on front of regulator.
 - c) Use 1/4" Allen key to adjust pressure.
 - d) Turn clockwise to increase pressure and counter clockwise to decrease pressure.
- i** **NOTE:** When lowering pressure, the bleed valve located on the cylinder requiring adjustment may be pushed to help relieve pressure.
- e) Push the bleed valve and release pressure to help stabilize the line and to ensure that the desired pressure has been achieved.
 - f) Close cabinet.
 - g) Replace cap nut on front of regulator.

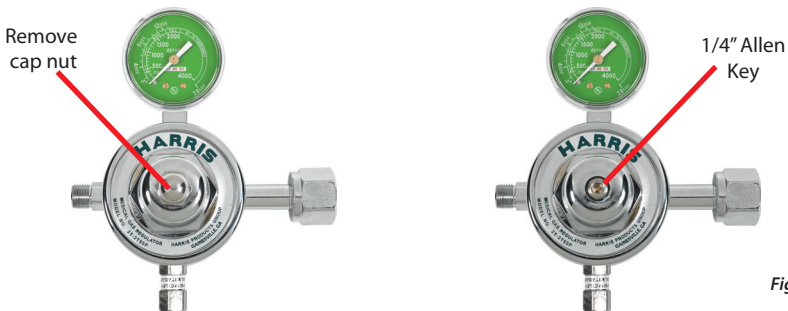

Figure 6

Testing

Testing for Automatic Changeover

1. Make sure the pressure is stable and the line pressures read 50PSI (pushing the Bleed Valves on all cylinders make certain the lines are stable). Once this has been confirmed, close the cylinder valve that is represented by the green LED.
2. Push the Bleed Valves on the same side as the closed cylinder, allowing the cylinder pressure to drop. Once the pressure gets below the low set point (40PSI), the system will change over to the reserve tank previously represented by the yellow LED. The closed cylinder will show a red "Empty" LED and the "In Use" cylinder will show a green LED.
3. An alarm will sound on both the manifold as well as the Remote Alarm Controller. You can mute the alarm using the Mute button.
4. Return the system to normal by S-L-O-W-L-Y opening the closed cylinder. Pressure will return to normal and the Empty cylinder will then be represented by a yellow "Reserve" LED.

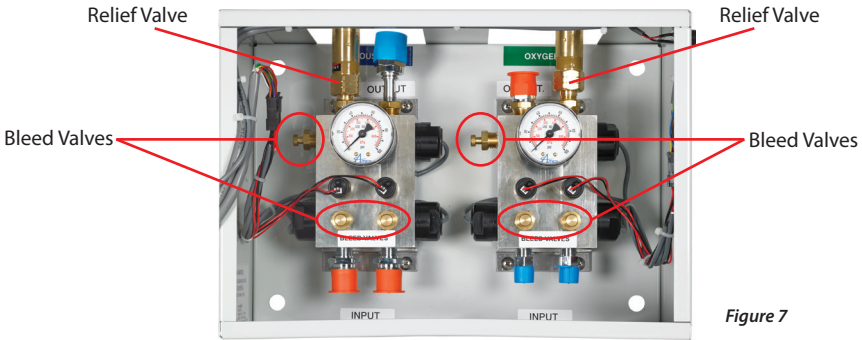

Figure 7

Testing for Nitrous Oxide Emergency Cut Off

1. Make sure the pressure is stable in both gases and the line pressures read 50 PSI. Once this has been confirmed, close BOTH nitrous oxide cylinder valves.
2. Open the cabinet to obtain access to the manifold blocks. Locate the dip switch on the circuit board and confirm switch #2 is in the OFF position.

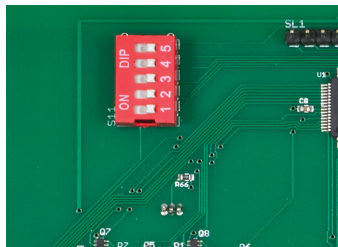

Figure 8

3. Open the flow of nitrous oxide in the rooms and scavenge the gases out of the room as you test the room. You should notice initial flow in the rooms, then a slowing of flow as the line pressure decreases and then eventually stopping. Close all flow in the rooms. An audio alarm will be heard at both the manifold and the RAC. Silence alarm by pressing the Mute button on either the manifold or RAC.

Testing

4. Close BOTH oxygen cylinder valves.
5. Locate the Bleed Valve for oxygen. (Refer to figure 7)
6. Slowly push the Bleed Valve and release pressure on the green "In Use" LED oxygen cylinder. An audio alarm will be heard at both the manifold and Remote Alarm Controller. Silence alarm by pressing the Mute button on either the manifold or RAC.
7. After change over has occurred, bleed the now active green "In Use" LED oxygen cylinder to simulate both tanks depleting. Once both pressures have been depleted, both tanks will be represented with red "Empty" LEDs and the LED display will read LO.
8. At this time, the nitrous oxide LED display will show OFF and will flash showing that the nitrous oxide has been closed due to lack of oxygen in the system. An audio alarm will be heard at both the manifold and the RAC. Silence the alarm by pressing the Mute button on either the manifold or RAC.
9. Locate gauge on the nitrous oxide block and note reading.
10. S-L-O-W-L-Y open the nitrous oxide cylinders one at a time.
11. The reading on the nitrous oxide gauge should not change.
12. S-L-O-W-L-Y open oxygen cylinders one at a time.
13. Pressure should return to normal for both the Oxygen and Nitrous Oxide. One tank, for each gas, will be represented by the green "In Use" LED and the other by the yellow "Reserve" LED.
14. Close manifold door.

Testing for Remote Alarm Controller

1. Make certain the RAC is connected via CAT5 or CAT6 cable.
2. Confirm the following:
 - a. Line pressure LEDs correspond to the manifold LEDs.
 - b. Reserve LEDs are green when the Reserve is ready to use, or red when the Reserve is empty.

LED Display Test

To test the system's LED's, press and hold the Mute button for five seconds. At this time, the manifold will begin a LED test and then return to normal working condition.

- LED test will light up each individual LED on the manifold and RAC.
- Confirm all LED's light up during the test to ensure the display is functioning correctly.

Cylinder Changing Procedure

1. Keep the "In Use" cylinder valve open throughout the procedure.
2. Close the cylinder valve on the empty cylinder.
3. Disconnect regulator from cylinder valve outlet using the appropriate wrench.
4. Place protective cap over cylinder valve of empty cylinder and move aside.
5. Remove protective cap from full cylinder. Visually inspect cylinder valve for dust, grease, and/or oil.
6. Wipe cylinder valve outlet clean using a clean lint free cloth. Do not use your fingers.
7. Standing to one side, "crack" the cylinder valve open by briefly opening and closing it to blow out any dust. Make sure it is pointing away from you and other personnel.
8. Connect regulator to the cylinder valve and tighten using the appropriate wrench.
9. Proceed to S-L-O-W-L-Y open cylinder valve.
10. The cylinder LED will change from red to yellow at the manifold. This indicates the reserve cylinder is in the ready state.
11. The red LED on the Remote Alarm Controller will turn off.
12. This completes the cylinder changing process. Repeat as required.



WARNING: High pressure oxygen systems must be handled with **CAUTION**.

Spontaneous combustion may occur if oxygen comes into contact with grease or oil. Ensure that hands, gloves, clothing and tools are kept clean and free from oil or grease. Be careful not to introduce dust or other contaminants into system when changing cylinders. Failure to comply with the procedure may be hazardous.



WARNING: Fire Hazard. **DO NOT** permit smoking, or any other source of ignition in area where the manifold is located, or near the relief valve vent outlet. Be certain that all connections are free of dirt, grease, and oil. These substances burn with great intensity in air enriched with oxygen, or nitrous oxide and some other gas mixtures.

Operation

SWITCHING THE “IN USE” CYLINDER

1. Open the cabinet to reveal the manifold interior. Locate the buttons on the inside of the circuit board.
2. Push the button and watch the LEDs switch between green “In Use” and yellow “Reserve”
 **NOTE:** This function will not be allowed if the reserve cylinder is empty or the pressure is too high.
3. Select the appropriate cylinder for “In Use”.
4. Close the manifold door and note pressures.



Figure 9

MUTE

The Mute button will silence any alarms until the manifold returns to a normal condition. After the Mute button has been pressed, the visual alarms (LEDs) will remain lit until the manifold returns to a normal condition. The alarm will sound again. If another alarm occurs, the alarm will not be cleared until the condition has been corrected.

SYSTEM STAND-BY

1. To place the system in “Stand-By Mode”, push and hold the Stand-by button for five seconds on either the manifold or the remote alarm. This safety feature prevents the system from entering the “Stand-By Mode” if the button is pressed accidentally.
2. When in “Stand-By Mode”, all solenoids will close restricting the flow of all gases. When in “Stand-By Mode”, a red LED, located below the Stand-By button, will illuminate. All other electronic components will turn off.

 **NOTE:** NFPA requires the cylinder tanks to be closed while the system is not in use.

3. To put the system back in operation, push the “Stand-By” button and open cylinders S-L-O-W-L-Y.
4. Check that all LEDs are in their normal status.

Line Drawing Manifold

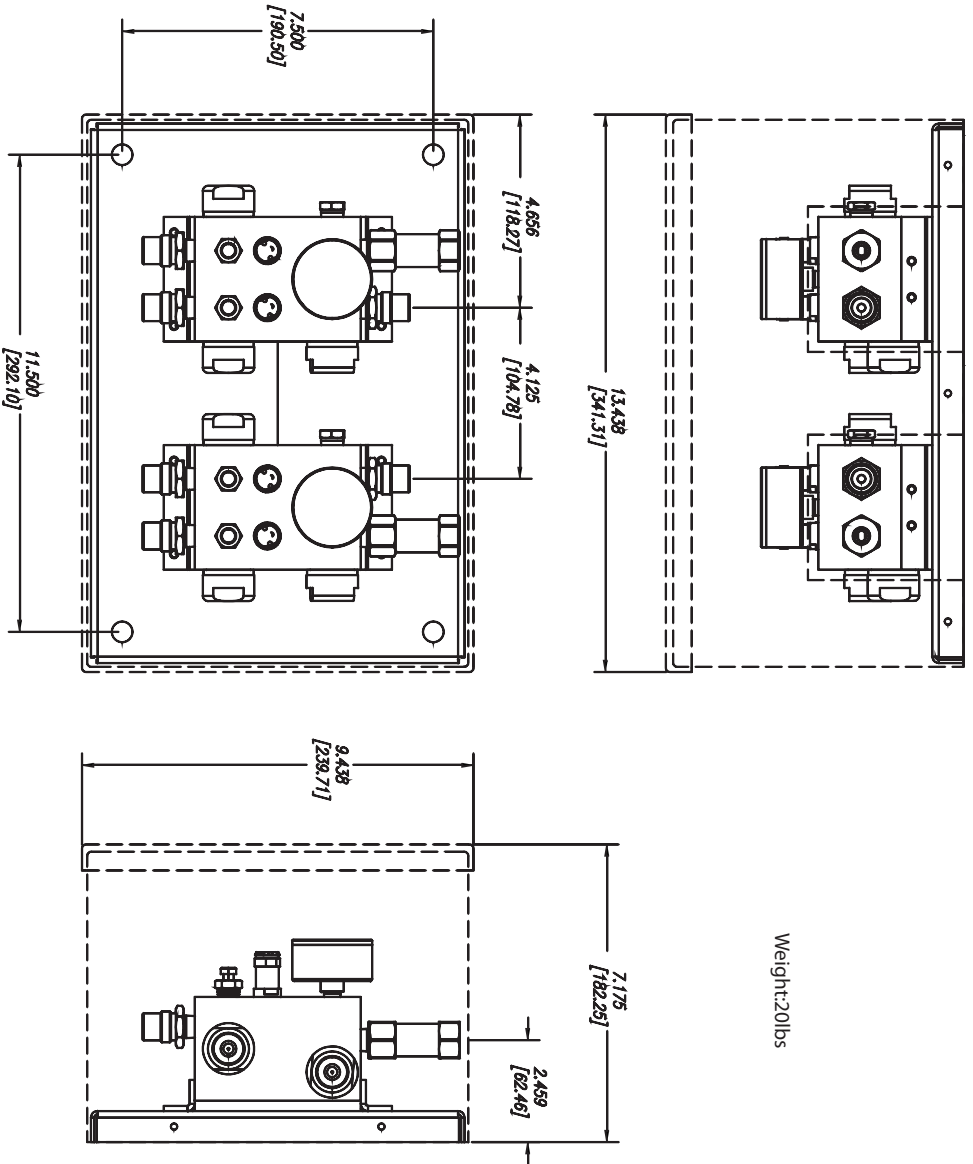

Purchase Record

MODEL NO.

SERIAL NO.

PURCHASE DATE

Notes

Warranty

Definition of Warranty Return: A product or part covered by the Belmed, Inc. warranty, that fails while the terms of the warranty are in effect.

THIS WARRANTY IS GIVEN IN PLACE OF ALL OTHER WARRANTIES, EXPRESSED OR IMPLIED, OF MERCHANTABILITY, FITNESS FOR A PARTICULAR PURPOSE OTHERWISE.

No statement or claim about the product by any employee, agent, representative or dealer of Belmed, Inc. shall constitute a warranty by Belmed, Inc. or give rise to any liability or obligation of Belmed, Inc.

Subject to the next sentence Belmed, Inc warrants that each product or part shall be free from defects in workmanship and materials, under normal use and with appropriate maintenance, for one (1) year from the date of delivery to customer. For plastic, rubber and disposable parts or items Belmed, Inc. warrants only that each such part and item shall be free from defects in workmanship and materials at the time of delivery to the customer.

Belmed, Inc.'s obligation for breach of this warranty, or for negligence or otherwise, shall be strictly and exclusively limited to Belmed Inc's choice of repair or replacement of the product or part. This warranty shall be void for any product on which the serial number has been altered, defaced or removed.

Belmed, Inc. shall not be liable for any damage, injury or loss arising out of the use of the product, whether as a result of a defect in the product or otherwise, if, prior to such damage, injury or loss, the product was (1) damaged, misused, or misapplied; (2) repaired, altered or modified by persons other than Belmed, Inc. (3) not installed in strict compliance with applicable codes and ordinances; or (4) not installed by Belmed, Inc. or an authorized Belmed, Inc. dealer.

UNDER NO CIRCUMSTANCES SHALL BELMED, INC. BE LIABLE FOR INCIDENTAL OR CONSEQUENTIAL DAMAGES AS THOSE TERMS ARE DEFINED IN THE UNIFORM COMMERCIAL CODE.

Manufactured by Amico Corporation, Distributed by Belmed Inc.

Line Drawing RAC

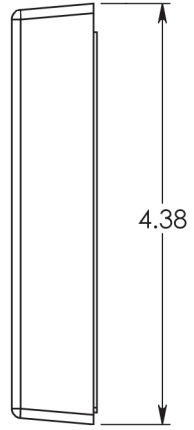
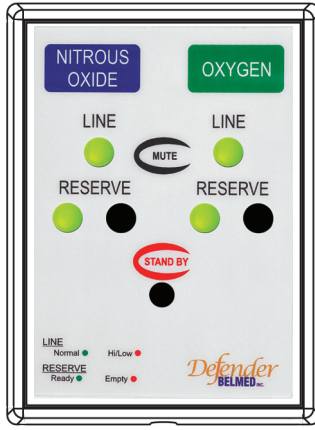

#6-32 small pattern Hex nut (1 supplied)

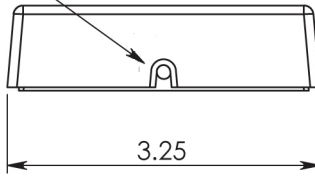

Single Gang Electric Box (not included)

#6-32 x 1" Pan Head Screw. (not included)

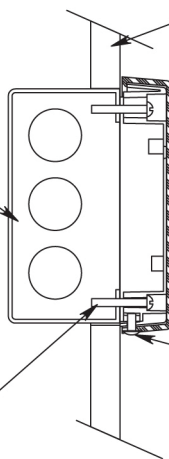

1/2" Drywall (not included)

#6-32 x 5/16" Button Head Screw. (1 supplied)

Installation Instructions

Installation of the Remote Alarm Controller (RAC)

1. RAC should be installed in a location that is continuously monitored while the facility is in operation.
2. From the manifold room run CAT5 cable from the manifold to the planned location of the RAC. Allow for excess cable on both ends to prevent tension on connections.
3. The RAC requires a single gang wall mount solution (please follow local code to provide a suitable rough in or low voltage trim). (Provided by installer.)
4. Remove RAC from packaging.
5. Loosen set screw located at the bottom of the RAC and remove front cover. Set cover aside (do not discard).
6. Plug CAT5 cable into the back of the RAC. Ensure the cable is “clicked” in and secure.
7. Use 2 screws to secure the RAC to the single gang wall mount solution.



NOTE: Be careful not to overtighten.

8. Re-attach the front cover to the RAC and tighten set screw
9. This completes the installation of the RAC. Continue installing the manifold by returning to page 11, step 13.



Order:

orders@belmedinc.com

Fax: 717-246-7586

Mail To:

PO Box 247

Red Lion, PA 17356

Ship To:

887 Delta Rd

Red Lion, PA 17356

Contact Us:

Local: 717-246-5500

Toll Free: 888-723-5893

bmi@belmedinc.com

Tech Support:

help@belmedinc.com

www.belmedinc.com

Installation Instructions

9. Install gas specific regulator on cylinder intended for operation. Be certain not to over tighten.



NOTE: Please check with your medical gas supplier to determine the correct torque needed to tighten the connection.

10. Using the two Oxygen and Nitrous Oxide 4' hoses, connect the appropriate hoses to the input lines located on the bottom of the manifold gas blocks.



NOTE: It is recommended to align cylinders on the wall in relation to the inputs on the manifold. This will allow for easier identification of tanks during setup/change-out.



NOTE: Use two wrenches.

11. Connect the loose end of the hoses to the gas specific DISS connection on the regulator.



NOTE: Use two wrenches.

12. Install Remote Alarm Controller (RAC) see page 12 for detailed instructions.

13. Connect CAT5 cable to manifold.

14. Open all cylinders S-L-O-W-L-Y and check for leaks using Snoop Leak Detector.



NOTE: Electrical power is required to operate the solenoids and restrict flow. Without electrical power, pressure will fill the lines.

15. Plug in manifold to a 120V power supply (do not use extensions cords).

16. Confirm that the manifold is on. LEDs should be lit.

17. Confirm the RAC is on. LEDs should be lit.

18. Complete testing on page 14 and 15 to ensure manifold is working correctly.

Description of Parts

Control Buttons

There are two control buttons located on the front face of the manifold and on the Remote Alarm Controller. They are the **Mute** and the **Stand-By** buttons.

MUTE

The Mute button will silence any alarms until the manifold returns to a Normal condition. After the Mute button has been pressed, the visual alarms (LEDs) will remain lit until the manifold returns to a Normal condition. The alarm will sound again if another alarm occurs. The alarm will not be cleared until the condition has been corrected.

The Mute button also serves as a test button. If the Mute button is held for 5 seconds, the manifold will run through a LED Display Test and then return to the current status. See page 15 for more information regarding LED Display Test.

STAND-BY

By pressing and holding the Stand-By button for five seconds, the manifold will go into stand-by mode, restricting the flow of both gases via the internal solenoids. As per NFPA 99 2012 5.3.6.19.4: "it shall be mandatory that cylinder shut off valves be closed whenever the system is not in use." This ensures that a dangerous condition will not occur if the lines are left open. Simply press the Stand-By button to return the manifold to full operation.

NOTE: If equipment in the operating room has not been fully closed while in Stand-by mode, the line pressure will be depleted. An initial alarm may occur immediately after returning the manifold into service. Once pressures have been re-established, all alarms should clear.

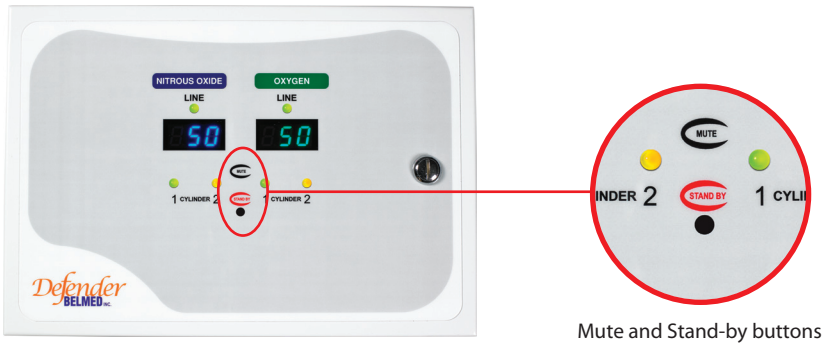
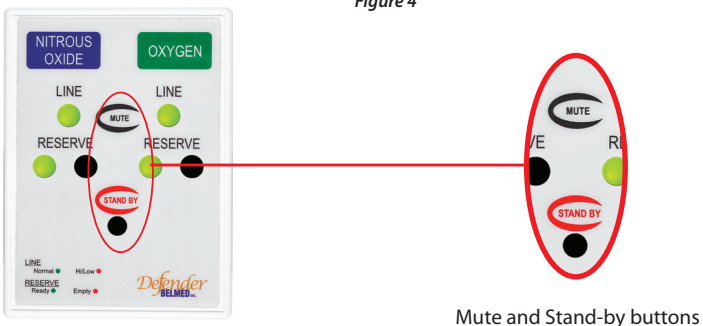

Figure 4



Manifold Package Details

Manifold Control Panel
Transformer
Remote Alarm Controller (RAC)
2x Oxygen Regulators
2x Nitrous Oxide Regulators
2x DISS Oxygen Hoses
2x DISS Nitrous Oxide Hoses

2x Double Tank Restraints
2x Regulator Hangers
Oxygen Pipeline Connector
Nitrous Oxide Pipeline Connector
Defender Cable
Instruction and Installation Manual

Description of Parts

Instruction/Installation Manual

Read this Instruction and Installation Manual completely prior to installing and operating this device.

Regulators

The package includes gas specific regulators that contain a gas specific CGA tank fitting, gauge and a gas specific DISS connection for the hose. The regulators are preset to 50PSI. Fluctuations in pressure may occur as tank pressure changes from full to empty. These regulators may be recalibrated by following Regulator Adjustment on page 13.



Regulator Hangers

Regulator hangers are included for storage of regulators during cylinder exchange.



Hoses

The package includes gas specific hoses. Each hose will have one end connected to the regulator and the other end connected to the manifold. It is recommended that the cylinders be positioned against the wall in a manner where the hoses do not cross (e.g. left tank on wall connects to the left connection on manifold).

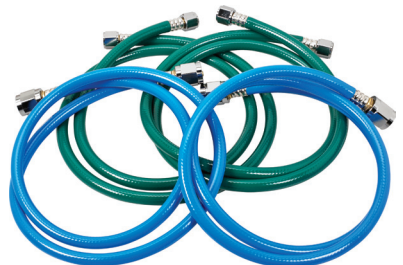

WARNING: Close all cylinders and bleed all pressure from within the manifold prior to removing or connecting any hoses. A hose under pressure (even with tanks closed) may cause harm to anyone near.